









br..... et bl..... + digraphes







1

Ecrire les syllabes dictées par l'adulte.



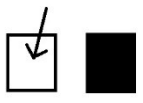
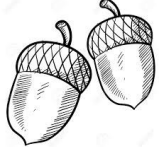

2

Pour chaque image, entoure la bonne syllabe.

 <p>flam pram cram fram</p>	 <p>fron trin tron cron</p>	 <p>froi croi proi cron</p>
 <p>blan blon flan vlan</p>	 <p>plan glan gran blan</p>	 <p>glou cou clou clon</p>

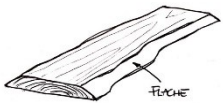
3

Pour chaque image, écris le nom représenté.

 <p>.....(1a)</p>	 <p>.....(1a)</p>	 <p>.....</p>
 <p>.....</p>	 <p>.....</p>	 <p>.....(0a)</p>



1 Ecrire les syllabes dictées par l'adulte.



.....



.....



.....



.....



.....



.....



.....



.....



.....

2 Pour chaque image, entoure la bonne syllabe.



flam pram
cram fram



fron trin
tron cron



froi croi
proi cron

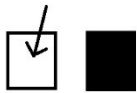

blan blon
flan vlan

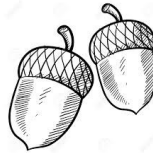

plan glan
gran blan



glou cou
clou clon

3 Pour chaque image, écris le nom représenté.



.....(1a)



.....(1a)



.....



.....



.....



.....(0a)

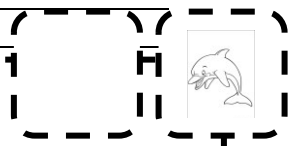

1

Ecrire les syllabes dictées par l'adulte.



.....



.....



.....



.....



.....



.....

2

Pour chaque image, entoure la bonne syllabe.



flam pram
fram



cron trin
tron



froi croi
proi



blan blon
flan

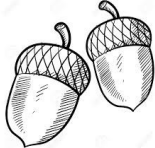

plan glan
blan



glou cou
clou

3

Pour chaque image, écris le nom représenté.



.....(1a)



.....(1a)



.....



.....

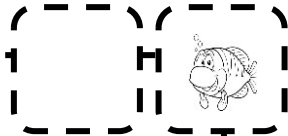

1 Ecrire les syllabes dictées par l'adulte.



.....



.....



.....



.....



.....



.....

2 Pour chaque image, entoure la bonne syllabe.



flam fram



cron tron

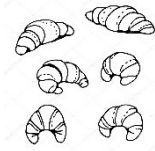

froi croi

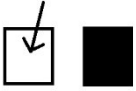

blan blon



plan glan



clou cou

3 Pour chaque image, écris le nom représenté.



.....(1a)



.....



.....



1

Ecrire les syllabes dictées par l'adulte.



.....



.....



.....

2

Pour chaque image, colorie la syllabe que tu entends.



bron	bran
------	------



trou	tron
------	------



croi	crou
------	------

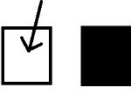

blou	blan
------	------



froi	fram
------	------



clou	flou
------	------



flan	plan
------	------



glan	gran
------	------



trou	crou
------	------

Enoncé



blon



crou



flan



troi



glin



frou



clan



fron



ploi